

Aplikace matematiky

Jozef Zámožík

Computer identification of plane regions

Aplikace matematiky, Vol. 27 (1982), No. 3, 209–222

Persistent URL: <http://dml.cz/dmlcz/103963>

Terms of use:

© Institute of Mathematics AS CR, 1982

Institute of Mathematics of the Czech Academy of Sciences provides access to digitized documents strictly for personal use. Each copy of any part of this document must contain these *Terms of use*.



This document has been digitized, optimized for electronic delivery and stamped with digital signature within the project *DML-CZ: The Czech Digital Mathematics Library* <http://dml.cz>

COMPUTER IDENTIFICATION OF PLANE REGIONS

JOZEF ZÁMOŽÍK

(Received September 3, 1980)

1. INTRODUCTION

Our aim is to give a simple algorithm for the computer identification of the insidedness and the outsidedness of a plane bounded region, i.e. an algorithm by means of which it is possible to determine whether a point belongs to the given region. The region itself can be arbitrarily complicated.

The algorithm can be applied in many ways, for example for determining the contour, the boundary of a region that can be the union, intersection or difference of an arbitrary number of k -tuply connected regions, further, for the graphic solution of an operation on abstract sets or for the determination of the projection outline of a polyhedron, for the automatic hatching of arbitrarily complicated regions etc. These problems belong to the characteristic problems of the computer graphics and image processing. Similar problems are solved e.g. in [1], [2], etc. See also the references in [1] and [4].

The solution of our problem was initiated in [3], where authors describe a special solution of the problem of a polyhedron's projection outline (the polyhedron is given by the wire model encoded by means of the TV camera and the laser beam, respectively).

Section 2 deals with the determination of the so-called r -value of the boundary of a simply connected region. In Section 3 we determine the so-called R -value of a region and in Sections 4 and 5 the R -value for the union, the intersection and the difference of regions. In Section 6 we deal with a k -tuply connected region. Section 7 offers several practical remarks and in conclusion indicates some possibilities of applications.

2. BASIC CONSIDERATIONS

Note 1. The constructions and theorems in this paper are elementary consequences of theorems of the set theory, geometry and algebra and they are constructed for

practical purposes. Therefore we omit the proofs of theorems. The correctness of theorems and the well-foundedness of definitions are evident.

In the plane, the basic element in our consideration will be the so-called simply connected (open) region R . It is bounded by a negative by oriented and closed line r (in short, boundary), which does not belong to the region and which does not intersect itself.

Note 2. Section 7 a negative by oriented and closed *broken* line will be considered as such a boundary.

Note 3. The negative orientation of the boundary r of a simply connected region R is the clockwise orientation, so that in the sense of the orientation the region lies to the right from its boundary.

Let us note that every straight line p generally intersects a boundary r in an even number of ordinary points. We will consider a point of fracture on the straight line p or a point of tangency on a tangent p as two identical points of the boundary r and of the line p as well.

Let p be an oriented line and φ_i the oriented angle between the line p and the tangent to the boundary (in this order) at its point of intersection P_i . Let $\{P_i\}$ be the sequence of points of intersection such that each pair of neighbouring points satisfies the following condition: The point P_i is before P_{i+1} (P_{i+1} is behind P_i) if and only if $t_i < t_{i+1}$, where t_i and t_{i+1} are the values of an increasing parameter of the oriented line p at the points P_i and P_{i+1} , respectively.

To an ordinary points of intersection P_i (for a case $\varphi_i \neq 0$) let us assign the so-called *r-value* 1 or -1 , such that (Fig. 1):

$$(1) \quad \begin{aligned} & 1 \quad \text{for } 0 < \varphi_i < \pi \\ & -1 \quad \text{for } \pi < \varphi_i < 2\pi \end{aligned}$$

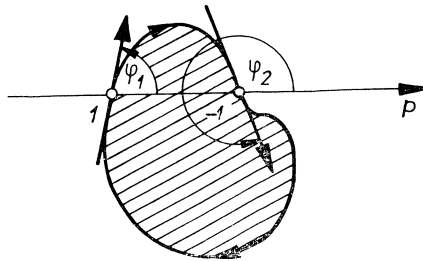

Fig. 1. The *r-value* 1 or -1 of ordinary points.

For the other points P_i (i.e. points of tangency, points of reversal and points of fracture) we define their *r-values* as follows (Fig. 2):

Let the point $P_{i \mp \Delta i}$ with $u_i \mp \Delta u$ for the value of the increasing parameter on the boundary (where $\Delta u (> 0)$ is sufficiently small) not lie on the line p and let its tangent be not parallel to the line p ; then we determine $\varphi_{i \mp \Delta i}$ (i.e. the angle between this

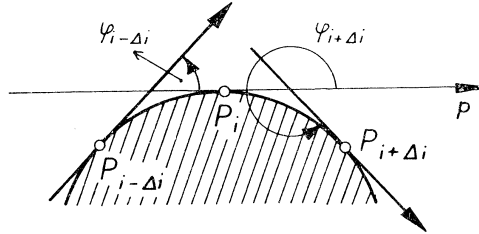

Fig. 2. To the r -value for the rest of points P_i .

tangent and the line p) and the r -values 1 or -1 as in (1) for an ordinary point of intersection. Then the so-called resulting r -value at the point P_i will be as given in Table 1.

$P_{i+\Delta i}$	1	-1
$P_{i-\Delta i}$	1	0
	-1	-1

Tab. 1.

Several examples of r -values are in Fig. 3.

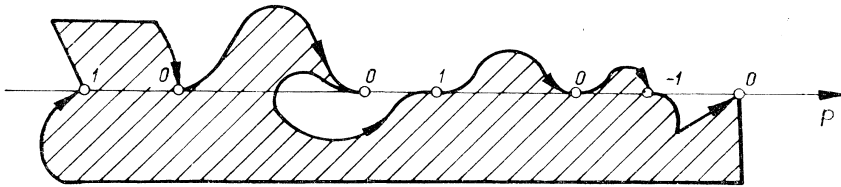

Fig. 3. The r -values for some points.

Note 4. Let the parameter u_i of a closed line r be from the interval $\langle a, b \rangle$. Moreover if $u_i = a$, then let $u_i - \Delta u = b - \Delta u$; if $u_i = b$, then $u_i + \Delta u = a + \Delta u$.

A special case occurs when part of the boundary is a segment on the line p . We omit this case for the present and we shall deal with it in detail only in the practical part (Section 7).

Note 5. The r -values at points of reversal and at such points of tangency that the line p is the tangent of the line r are defined in this section for the completeness. With regard to Note 2 we shall not use these values for practical purposes.

3. R -value

Let M be a point and R a simply connected region in the plane. Let us assign to the point M the so-called R -value 0 if $M \notin R$ and the R -value 1 if $M \in R$. The points on a boundary r have the R -value 0 because they do not belong to the region.

Now we will define the R -value for the points lying on the line p . Let k_i^p be the r -value (or the resulting r -value) at the point P_i and K_i^p the R -value between P_i and P_{i+1} (or behind the point P_i if P_i is the last common point of the line p and the boundary). Then

$$(2) \quad K_i^p = \sum_{j=1}^i k_j^p$$

It is obvious that R -value of all points on the line p before the point P_1 is 0. Moreover, $K_1^p \neq -1$ and $K_n^p = 0$ where K_n^p is the R -value with regard to the point P_n that is the last intersection of the line p and of the boundary r . These assertions follow directly from the definition of the R -values and r -values on the line p (for example the r -value $k_i^p = -1$ implies that the region with regard to (2) is not negative oriented (Fig. 4)).

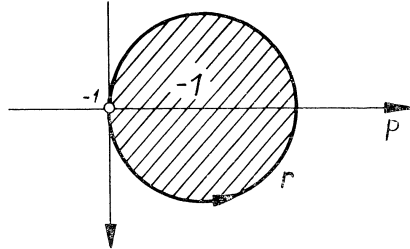

Fig. 4. The r -value and the R -value for a positive oriented region.

An example of R -values on the line p is in Fig. 5.

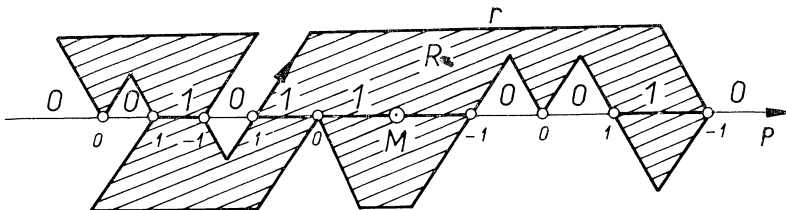

Fig. 5. Example of R -values on the line p (and at the point M).

Example 1. Using the foregoing considerations we can solve the problem: determine whether a point M belongs to the region R .

Algorithm.

1. Let us choose an oriented line p through the point M and detect its points of intersection with the boundary r (see Fig. 5).
2. If $P_i = M$ for some P_i then $K_i^p = 0$ at M and the point M does not lie in the region (then STOP follows).
3. If $P_i \neq M$ for all P_i then we construct a sequence $\{P_i\}$ by means of the increasing parameter of the line p and we determine all r -values k_i^p up to the point P_i which is the nearest to M at the same time satisfies $t_p < t_M$ (t_p and t_M are the values of the parameter for the points P_i and M).
4. Let us determine the R -value K_i^p according to (2). If $K_i^p = 0$ then the point M does not lie in the region; if $K_i^p = 1$ then the point M lies in the region R .

4. R -value OF A REGION THAT IS THE INTERSECTION OR UNION OF REGIONS

Let ${}^1R, {}^2R, \dots, {}^sR$ be simply connected regions and p a straight line. If the case $P_h = {}^rP_i = \dots = {}^vP_j$ occurs, where ${}^rP_i, \dots, {}^vP_j$ are the intersections of the regions and of the line p then the r -value (of the boundary) at the point P_h is ${}^rk_i + \dots + {}^vk_j = k_h$. In Fig. 6 the r -value for the point $P_5 = {}^1P_2 = {}^2P_4$ is $k_5 = {}^1k_2 + {}^2k_4 = -1 + (-1) = -2$.

Let there exist a point that belongs to each of the regions ${}^1R, {}^2R, \dots, {}^nR$. Let us assign the R -value n to this point. Then in general the R -value of the region $R = {}^1R \cap {}^2R \cap \dots \cap {}^nR$ obviously is at most n .

Now we determine the R -value of an intersection of regions on the line p . Let k_h^p be the r -value (or the resulting r -value) at the point P_h . If P_h and P_{h+1} are the neighbouring points common to the line p and to one of the boundaries of the given regions then we label by K_h^p the R -value on the line p between the points P_h and P_{h+1} . If P_h is the last point common to the line p and to one of the boundaries then we

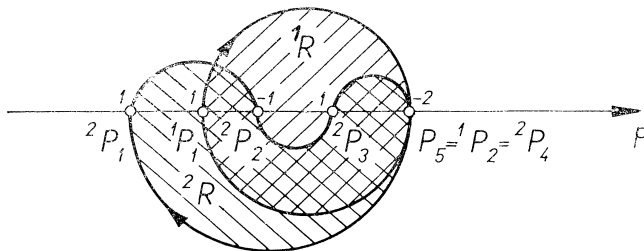

Fig. 6. The r -value at the double point P_5 .

label by K_h^p the *R-value* on the line p behind the point P_h . Then the *R-value* of the points of the line p between the points P_h and P_{h+1} (or behind the point P_h) is:

$$(3) \quad K_h^p = \sum_{g=1}^h k_g^p.$$

The *R-value* at the point P_h is $K_h^p - k_h^p$.

The competence of our definition follows from the set operation of intersection because $0 \leq K_h^p \leq n$.

Note that the construction of the *R-value* immediately implies

$$(4) \quad K_h^p = K_{h-1}^p + k_h^p.$$

Example 2. Let regions ${}^1R, {}^2R, \dots, {}^nR$ and a point M be given in the plane. Determine the *R-value* of the intersection of those regions which contain the point M .

Algorithm.

1. We choose an oriented line p through the point M and detect its intersections with the boundaries of the regions.

2. Let us construct a sequence $\{P_h\}$ by means of the increasing parameter of the line p and let us determine all the resulting *r-values* k_h^p up to the point P_h that is the nearest point to the point M for which $t_p \leq t_M$ (t_p and t_M are the values of the parameter of the line p at the point P_h and M).

3. We determine the *R-value* K_h^p using (3). If $P_h \neq M$ then the *R-value* of the intersection at the point M is K_h^p ; if $P_h = M$ then this *R-value* is $K_h^p - k_h^p$.

In Fig. 7 the point M lies in the intersection of three out of four regions because $K_6^p = 1 + 1 - 1 + 1 + 0 + 1 = 3$. The point P_6 has the *R-value* $K_6^p - 1 = 3 - 1 = 2$.

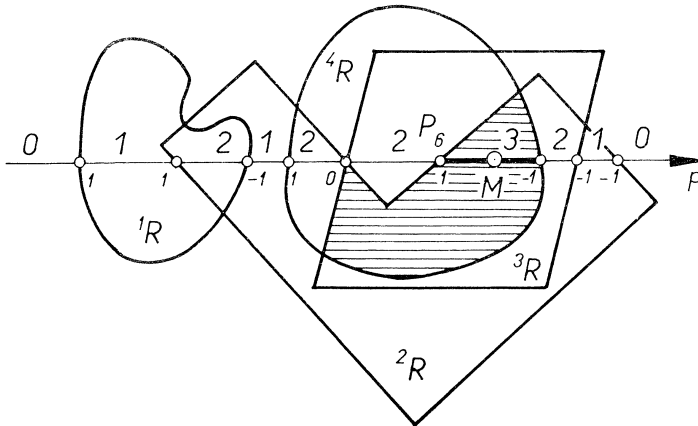

Fig. 7. The *R-value* at the points M and P_6 .

The above algorithm can be used e.g. for a solution of the following problems:

1. To mark (e.g. by hatching) the intersection for a given R -value (if it exists).
2. To mark the boundary of this intersection.
3. To mark the union of an arbitrary number of region.
4. To mark the boundary of this union.

We solve Problems 1 and 2 so that we detect (on a suitable number of parallel straight lines) such segment $P_h P_{h+1}$ whose inside points have the given R -value. Then the points P_h and P_{h+1} lie on the boundary of the intersection.

Problems 3 and 4 (concerning the union) is solved by detecting (on the suitable number of a parallel straight lines) the line segments $P_h P_{h+1}$ whose in their inside points have the R -value at least 1. The points P_h, P_{h+1} (on parallel lines) with the R -values 0 are the points of the boundary of the union.

Note 6. The R -value of the inside points of the segment $P_h P_{h+1}$ can be determined advantageously by means of (4).

5. R -value OF THE DIFFERENCE OF REGIONS

Let us label by \bar{R} a simply connected region in the plane with a positive by oriented boundary (i.e. counterclockwise, so that in the sense of this orientation the region lies to the left from its boundary). We retain the method for determining the r -values of the boundary and of the R -values of the region as in the previous section. Then the R -value of the inside of the region is -1 (Fig. 8).

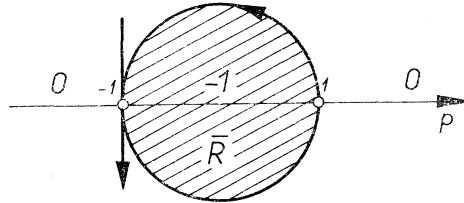

Fig. 8. The r -values and the R -value for the \bar{R} region.

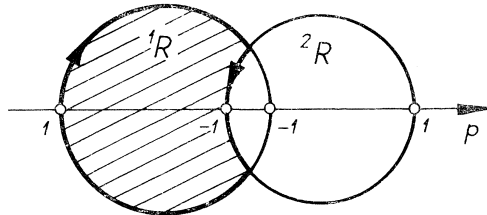

Fig. 9. The difference of regions $^1R, ^2R$ by means of the union $^1R \cup ^2R$.

Let us have two regions 1R and 2R . We construct their difference ${}^1R \setminus {}^2R$ by means of the union ${}^1R \cup {}^2\bar{R}$ (Fig. 9).

6. k -TUPLY CONNECTED REGIONS

Using the region \bar{R} we can simply define a k -tuply connected region (i.e. a region with the boundary that is formed by k disjoint closed lines).

Definition. If ${}^1R, {}^2R, \dots, {}^nR$ are simply connected regions, if ${}^2R \cap {}^1R = {}^2R, {}^3R \cap {}^1R = {}^3R, \dots, {}^nR \cap {}^1R = {}^nR$ and the intersections of the other pairs of regions

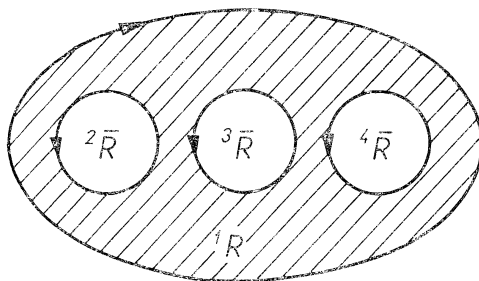

Fig. 10. To the k -tuply connected region.

are empty then the region ${}^1R \cup {}^2\bar{R} \cup {}^3\bar{R} \cup \dots \cup {}^n\bar{R}$ is an n -tuply connected region. Fig. 10 shows a 4-tuply connected region.

* * *

Fig. 19 and Fig. 20 show a more complicated example of the set operations on the regions.

7. TECHNICAL NOTES

1. In computer processing, a curve is usually approximated by a *broken* line. Then in our case, a simply connected region is a polygon (without the boundary). The problem of finding the intersections of the straight line p and the boundary r is then reduced to the problem of finding the intersections of this straight line and any side of the polygon.

2. To simplify the computations we shall suppose that the line p is parallel to the axis x (from the coordinate system Oxy), which can always be reached by a suitable rotation of the coordinate system. Let x_i, y_i be the coordinates of the vertex V_i

of the region R . The neighbouring vertices to the vertex V_i are V_{i-1} and V_{i+1} . The vertex V_i is joined by sides with the vertices V_{i-1} and V_{i+1} .

3. If a point P_i is an inside point of the side $V_i V_{i+1}$ of the boundary then the r -value at this point can be determined as follows (instead of determining it by the angle φ_i):

Let the equation of the line p (which is oriented in the same sense as the axis x) be $y = y_0$;

- a) if $y_i < y_0 < y_{i+1}$ then the r -value at the point P_i is 1,
- b) if $y_{i+1} < y_0 < y_i$ then the r -value at the point P_i is -1 (Fig. 11).

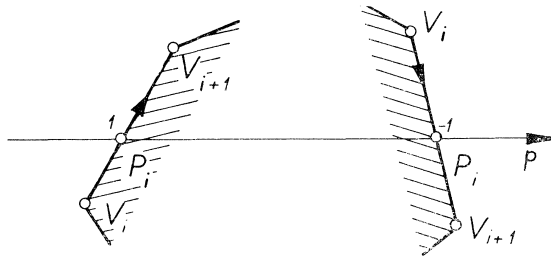

Fig. 11. To determining the r -value on the broken line boundary.

4. Let $P_i = V_i$ (neither $V_{i-1} V_i$ nor $V_i V_{i+1}$ being parallel to the axis x). Then the r -value at this point will be (cf. Table 1):

- 1, if $y_{i-1} < y_i < y_{i+1}$;
- -1 , if $y_{i+1} < y_i < y_{i-1}$;
- 0, if $y_{i-1} < y_i \wedge y_{i+1} < y_i$;
- 0, if $y_i < y_{i-1} \wedge y_i < y_{i+1}$ (Fig. 12).

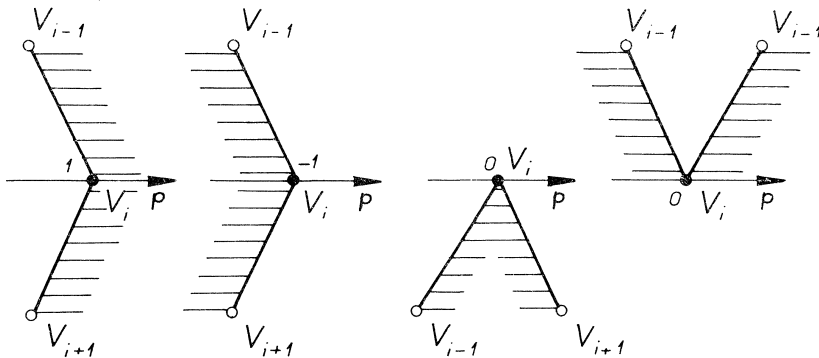

Fig. 12. The R -values at the vertices.

5. Let $V_i V_{i+1} \parallel x$. Then we assign no r -value to the inside points on the side $V_i V_{i+1}$. For the points $V_i = P_j$ and $V_{i+1} = P_k$ we first determine the so-called preliminary r -values:

- If $y_{i-1} < y_i$ then the preliminary r -value at V_i is 1,
- if $y_i < y_{i-1}$ then the preliminary r -value at V_i is -1 ,
- if $y_{i+2} < y_i$ then the preliminary r -value at V_{i+1} is -1 ,
- if $y_i < y_{i-2}$ then the preliminary r -value at V_{i-1} is 1.

We determine the resulting r -values of the boundary at the points V_i and V_{i+1} from Table 2. Here we re-label the points V_i, V_{i+1} by A, B in such a way that the

preliminary r -value			resulting r -value	
A	B	\Rightarrow	A	B
-1	1	\Rightarrow	-1	1
1	-1	\Rightarrow	0	0
-1	-1	\Rightarrow	-1	0
1	1	\Rightarrow	0	1

Tab. 2.

x -coordinate of the point A is less than the x -coordinate of the point B . Fig. 13 shows an example a) of the preliminary r -values, b) of the resulting r -values for the vertices of the boundary for this special case.

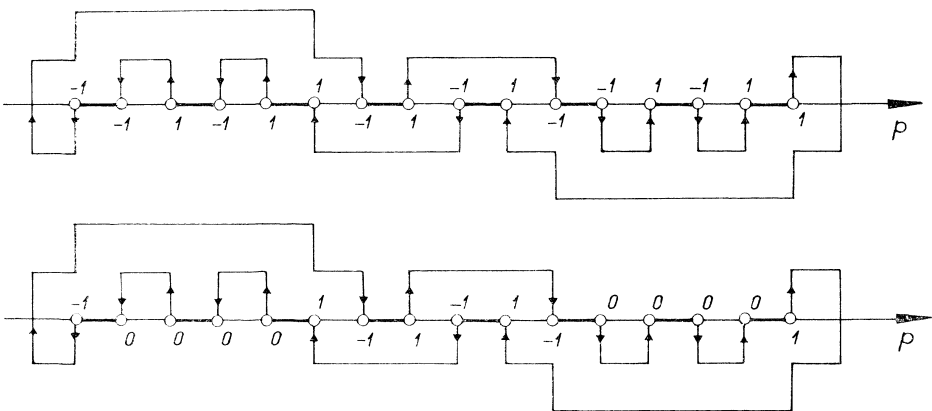

Fig. 13. Example a) of preliminary r -values and b) of resulting r -values.

6. The R -values of the k -tuply connected region, the R -values of the intersection, the union and the difference of these regions are determined, as in the foregoing sections. In the case that one of a region iR belongs to the line p and this side contains the point P_h of intersection of the boundary of another region jR and the line p (Fig. 14), then the resulting r -value at this point is just the r -value at the point P_h with

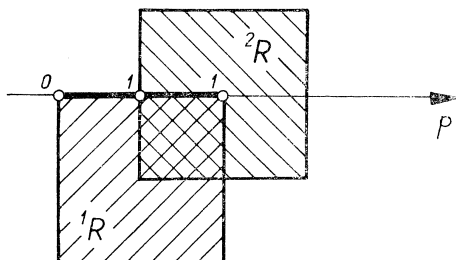

Fig. 14. The r -value at a point that belongs to the side.

regard to the region jR (cf. Note 5 in this section). If sides of more regions lie on the line p and they have a common intersection then we determine by using Note 5 of this section only the r -values at the endpoints of these sides (in Fig. 15 there are two cases of such two regions).

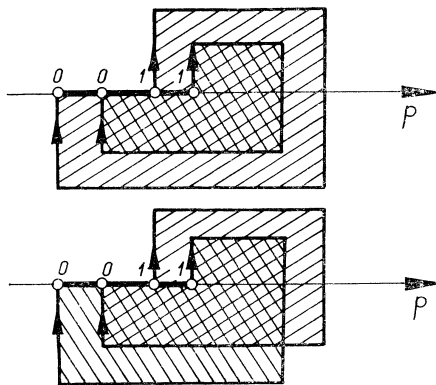

Fig. 15. The r -value at the endpoint of the intersection of the sides.

8. EXAMPLES

We present some suggestions for the application of our method.

1. When solving the visibility of solid objects on the plotter, display or alphanumeric high-speed printer it is necessary first to detect whether the given point is occluded

(in projection) by some object. In Fig. 16(a) and 17(a) the point M does not lie in the region that is given by the projection of the object, in Fig. 16(b) and 17(b) the point M lies in this region.

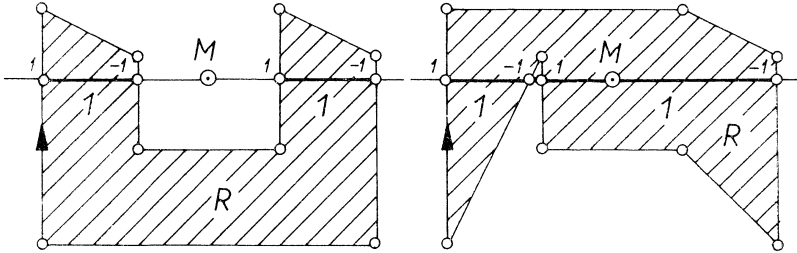

Fig. 16 (a) and (b). The point M and the region.

2. The relative visibility of a face of a polyhedron can be determined by means of the position of the outside normal vector of this face to the center of projection (see e.g. [3]). An other method is as follows: To the outside of the boundary of the face let us assign the negative by oriented boundary. If the projection of the poly-

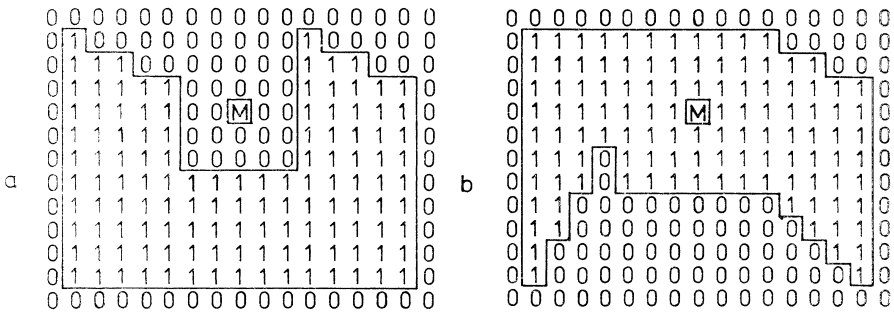

Fig. 17 (a) and (b) The point M and the region.

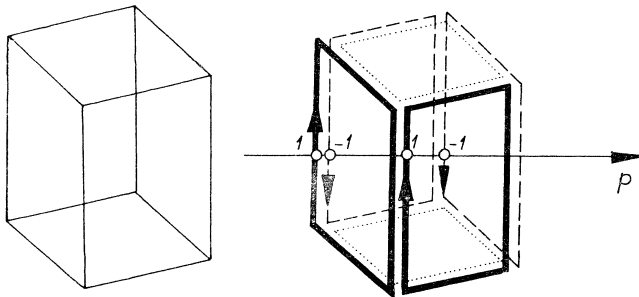

Fig. 18. To the detection of visibility of the face.

hedron face has a positive by oriented boundary then the face is occluded. It is sufficient to detect the r -value of the first point of intersection of the boundary and any line p (Fig. 18).

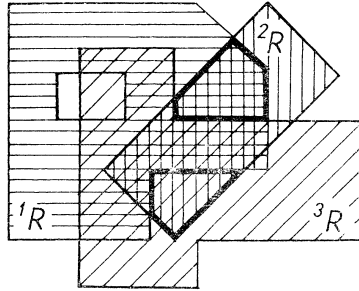

Fig. 19. To the detection of the union, intersection or difference of regions.

3. Hatching (or indication by a sign) of the region that is given by intersection, union and difference of more regions can be another example for using the given method. Fig. 19 shows a full two times hatched region $(^1R \setminus ^3R) \cap ^2R$ and the region $(^3R \setminus ^1R) \cap ^2R$. In Fig. 20 these regions are labelled by D and I , respectively.

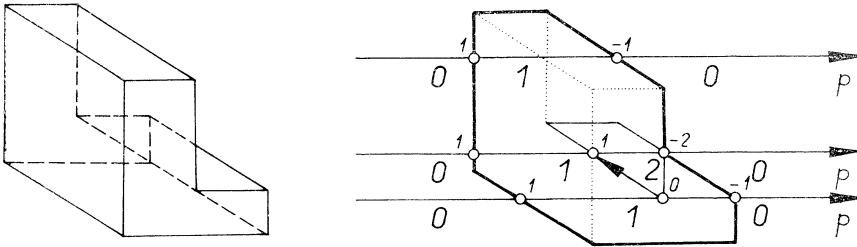

Fig. 20. To the detection of the regions that are labelled by characters.

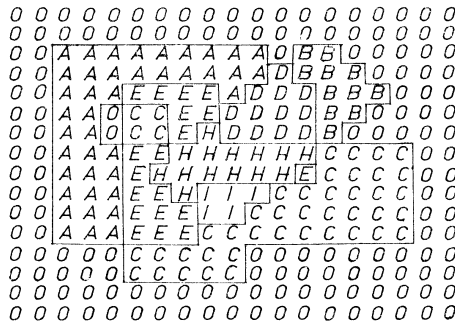

Fig. 21. Detecting the boundary of the projection of an object.

4. The boundary of the union viewed as the outline of the projection of a polyhedron [3]. In fact, it is the line composed of the points between the region with the R -value 0 and the R -value that is greater than 0 (Fig. 21). By our method differing from the one used in [3] we can determine the r -value at an arbitrary point of the boundary by (just) one line p that goes through this point.

References

- [1] *P. Lemkin*: The Run Length Map: A Representation of Contours and Regions for Efficient Search & Low Level Semantic Encoding Comp. Science Technical Report Series, Univ. of Maryland, Apr. 1978.
- [2] *M. Minsky* and *S. Papert*: Perceptrons — an Introduction to Computational Geometry. MIT Press, Cambridge, Mass, 1969.
- [3] *D. Nitzan* and *G. J. Agin*: Fast Methods for Finding Object Outlines. Computer Graphics and Image Processing 1 (1979), 22—39.
- [4] *A. Rosenfeld*: Survey — Picture Processing: 1978, Computer graphics and Image Processing 4 (1979), 354—393.

Súhrn

POČÍTAČOVÁ IDENTIFIKÁCIA ROVINNEJ OBLASTI

JOZEF ZÁMOŽIK

Pomocou R -hodnôt bodov rovinnej oblasti, resp. r -hodnôt hranice oblasti možno identifikovať body oblasti a ich hranice, pričom výsledná oblasť môže byť produktom (množinových) operácií na ľubovoľnom množstve k -násobne súvislých oblastí.

Author's address: Doc. Dr. Jozef Zámožik, CSc., Stavebná fakulta SVŠT, Radlinského 11, 813 68 Bratislava.