

Waseem Abbasi; Fazal ur Rehman; Ibrahim Shah

Smooth super twisting sliding mode based steering control for nonholonomic systems transformable into chained form

Kybernetika, Vol. 54 (2018), No. 3, 476–495

Persistent URL: <http://dml.cz/dmlcz/147432>

Terms of use:

© Institute of Information Theory and Automation AS CR, 2018

Institute of Mathematics of the Czech Academy of Sciences provides access to digitized documents strictly for personal use. Each copy of any part of this document must contain these *Terms of use*.



This document has been digitized, optimized for electronic delivery and stamped with digital signature within the project *DML-CZ: The Czech Digital Mathematics Library* <http://dml.cz>

SMOOTH SUPER TWISTING SLIDING MODE BASED STEERING CONTROL FOR NONHOLONOMIC SYSTEMS TRANSFORMABLE INTO CHAINED FORM

WASEEM ABBASI, FAZL UR REHMAN AND IBRAHIM SHAH

In this article, a new solution to the steering control problem of nonholonomic systems, which are transformable into chained form is investigated. A smooth super twisting sliding mode control technique is used to steer nonholonomic systems. Firstly, the nonholonomic system is transformed into a chained form system, which is further decomposed into two subsystems. Secondly, the second subsystem is steered to the origin by using smooth super twisting sliding mode control. Finally, the first subsystem is steered to zero using signum function. The proposed method is tested on three nonholonomic systems, which are transformable into chained form; a two-wheel car model, a model of front-wheel car, and a fire truck model. Numerical computer simulations show the effectiveness of the proposed method when applied to chained form nonholonomic systems.

Keywords: nonholonomic mechanical systems, chained form, steering control, smooth super twisting sliding mode control and lyapunov function.

Classification: 93C85, 70Q05

1. INTRODUCTION

In the past decade, control of nonholonomic mechanical systems has attracted much attention of the control community because of the vast practical applications in diverse fields. Due to the mechanical design and configuration, these systems have constraints on their motion. These constraints can be classified into two categories: holonomic and nonholonomic. Holonomic constraints are of the form $\varphi(\dot{q}) = 0$, and are integrable, i. e., can be written as $\psi(q) = 0$. On the other hand, nonholonomic constraints are of the form $\varphi(q) = 0$, and are non-integrable, i. e., cannot be written as $\psi(q) = 0$. Here $\psi(q)$ represents the position function of the nonholonomic system.

Nonholonomic systems belong to a special class of nonlinear systems and are frequently encountered in our daily life, e. g. while driving a car to work, pushing a baby stroller, or riding a bicycle to school. One of the challenging problem in control of nonholonomic systems is point stabilization to the desired point e. g. parallel parking of the car. In particular, wheeled mobile robots are typical examples of nonholonomic mechanism due to the perfect rolling constraints on the wheel motion (e. g. no longitudinal or

lateral slipping).

In recent years, various control design techniques have been proposed for nonholonomic systems in chained form, and much effort has been devoted to the stabilization and tracking control, see [5, 7, 10, 19, 20]. Among the techniques mentioned in the literature, Sliding Mode Control (SMC) has attracted much attention of the researchers due to its simplicity, fast response, and robustness to external noise and parameter variation [1, 11, 21]. However, one major drawback of SMC is the presence of the chattering effect, caused by the switching frequency of the control. The high-frequency components propagate through the system, excite the unmodeled dynamics and therefore cause undesired oscillations. In fact, this can degrade the system performances or may even lead to instability.

In the literature, three main approaches have been presented to reduce the chattering effect. The first class of methods uses saturation functions instead of the signum function. The second class of methods is based on the use of a system observer and the third class of methods uses higher order sliding mode controllers to reduce the chattering phenomenon, and to keep the system on the desired manifold. The most advantageous of these approaches to eliminate chattering is the third class of methods [4].

The higher order sliding mode uses differentiators and sliding mode manifold estimators (as shown in [8]) to maintain the robustness of the system. The second order sliding mode control (such as the smooth super-twisting sliding mode control) is relatively simple to implement and it provides good robustness to external disturbances. In recent years, smooth super-twisting sliding mode control theory has become very popular and therefore, it has been widely used to control systems with uncertainties. The smooth super-twisting sliding mode control allows finite time convergence of the sliding variable as well as its derivative to zero [6, 16, 18]. The sophisticated control law guarantees the robustness, but for the price of increasing the transient time. To improve the transient time of this control approach, a Lyapunov function has recently been constructed as shown in [13]. This function is used to estimate the convergence time for super twisting algorithm [12]. In [15], a super twisting structure is presented to analyze the stability using the ideas of a Lyapunov function given in [13].

This article presents a method for designing steering control laws for a nonholonomic system in chained form. The methodology depends on smooth super twisting sliding mode control. The main objective is the steering of the nonholonomic system in the presence of disturbance and unmodeled dynamics. Smooth super twisting sliding mode controller is used to further reduce or suppress the chattering effect. Control design methodology is first developed for the general case and then applied to specific cases. The design of control law based upon smooth super twisting sliding mode for the steering control of the nonholonomic systems contributes to the motivation for the proposed control design.

In this article, firstly, the nonholonomic system is transformed into a chained form system. Secondly, the chained form system is decomposed into two subsystems S_1 and S_2 by assuming first input $u_1 = 1$. The subsystem S_1 consists of single state variable x_1 , while the subsystem S_2 consists of remaining state variables, i. e. x_2, x_3, \dots, x_n . Then the subsystem S_2 is steered to the origin by using smooth super twisting sliding mode controller. Finally, the subsystem S_1 is steered to zero using signum function. The

proposed method is tested on three mechanical nonholonomic systems, that are transformable into a chained form; a two-wheel car model, a model of front-wheel car and a firetruck model. The simulation results show the validity of the proposed controller for the original nonholonomic systems.

The rest of the article is organized as follows. Section 2 presents control problem formulation. Section 3 presents the proposed control methodology in its general form. Section 4 presents application examples along with the simulation results and finally, Section 5 concludes the paper.

2. THE CONTROL PROBLEM FORMULATION

Due to the presence of the nonholonomic constraint, the kinematics model of nonholonomic systems are generally described by:

$$\dot{z} = \sum_{i=1}^m Z_i(z) u_i, \quad z \in \mathfrak{R}^n \quad (1)$$

where Z_i , $i = 1, \dots, m$, are linearly independent vector fields on \mathfrak{R}^n , u_i are piecewise continuous and locally bounded in t control functions defined on the interval $[0, \infty)$. In control system design it is very useful technique that the system is first transformed into some canonical form via state – input transformation. One such canonical form is chained form introduced first time by [14]. It has been shown in [3] that many nonholonomic mechanical systems can be either locally or globally converted to the so-called chained form under a coordinate and input transformations. As a result, the chained form has been used as a canonical form in analysis and control design for nonholonomic systems. The simplest chained system obtained from (1) for $m = 2$ is a nonlinear system that has two control inputs (v_1, v_2) and n outputs (x_1, x_2, \dots, x_n) , where, $n > 2$. The general chained form system can be written as:

$$\begin{aligned} \dot{x}_1 &= v_1 \\ \dot{x}_2 &= v_2 \\ \dot{x}_3 &= x_2 v_1 \\ \dot{x}_4 &= x_3 v_1 \\ &\vdots \\ \dot{x}_n &= x_{n-1} v_1. \end{aligned} \quad (2)$$

Given a desired setpoint $x_{des} \in \mathfrak{R}^n$, construct a feedback strategy in terms of the controls $v_i : \mathfrak{R}^n \rightarrow \mathfrak{R}$, $i = 1, 2$, such that the desired setpoint x_{des} is an attractive set for (2), so that there exists an $\varepsilon > 0$, such that $x(t; 0, x_0) \rightarrow x_{des}$, as $t \rightarrow \infty$ for any initial condition $x_0 \in B(x_{des}; \varepsilon)$.

Without the loss of generality, it is assumed that $x_{des} = 0$, which can be achieved by a suitable translation of the coordinate system.

Assumptions:

For steering problem, the control systems described by (1) must satisfy the following conditions.

- (P1): The vector fields $Z_1(z), \dots, Z_m(z)$ are linearly independent.
- (P2): System (1) satisfies the LARC (Lie algebra rank condition) for accessibility, namely that the Lie algebra, $L(Z_1, \dots, Z_m)(z)$ spans \mathfrak{R}^n at each point $z \in \mathfrak{R}^n$.

3. THE PROPOSED STEERING CONTROL ALGORITHM

Step 1:

Choose $v_1 = 1$ and $v_2 = v$, then system (2) becomes:

$$\begin{aligned}
 \dot{x}_1 &= 1 \\
 \dot{x}_2 &= v \\
 \dot{x}_3 &= x_2 \\
 \dot{x}_4 &= x_3 \\
 &\vdots \\
 \dot{x}_{n-1} &= x_{n-1} \\
 \dot{x}_n &= x_{n-1}.
 \end{aligned} \tag{3}$$

Step 2:

Decompose the system (3) into two subsystems as:

$$\begin{aligned}
 S_1 : \dot{x}_1 &= 1 \\
 S_2 : \left\{ \begin{array}{l} \dot{x}_n = x_{n-1} \\ \dot{x}_{n-1} = x_{n-2} \\ \vdots \\ \dot{x}_4 = x_3 \\ \dot{x}_3 = x_2 \\ \dot{x}_2 = v. \end{array} \right.
 \end{aligned} \tag{4}$$

Define the sliding surface for subsystem S_2 as:

$$s = x_n + \sum_{i=1}^{n-3} c_i x_{n-i} + x_2, \tag{5}$$

where $c_i > 0$ are chosen in such a way that s becomes Hurwitz polynomial. Then

$$\dot{s} = \dot{x}_n + \sum_{i=1}^{n-3} c_i \dot{x}_{n-i} + \dot{x}_2 = x_{n-1} + \sum_{i=1}^{n-3} c_i x_{n-1-i} + v. \tag{6}$$

By choosing

$$v = v_{eq} + v_s \tag{7}$$

where

$$v_{eq} = -x_{n-1} - \sum_{i=1}^{n-3} c_i x_{n-1-i} \tag{8}$$

$$v_s = -k_1 |s|^{\frac{\rho-1}{\rho}} \text{sign}(s) + z \tag{9}$$

$$\dot{z} = -k_2 |s|^{\frac{\rho-2}{\rho}} \text{sign}(s) \tag{10}$$

where $k_1, k_2 > 0, \rho \geq 2$,

we have

$$\dot{s} = -k_1 |s|^y \text{sign}(s) + z \tag{11}$$

$$\dot{z} = -k_2 |s|^{y-\frac{1}{\rho}} \text{sign}(s) \tag{12}$$

where $k_1, k_2 > 0, y = \frac{\rho-1}{\rho}$. Therefore the subsystem S_2 is stable.

The stability proof of system (11) and (12) is based on the context given in reference [12] as shown below:

Define:

$$\zeta^T = [|s|^y \text{sign}(s) \quad z] \tag{13}$$

Then

$$\begin{aligned} \dot{\zeta} &= \begin{bmatrix} y|s|^{y-1} \dot{s} \\ \dot{z} \end{bmatrix} = \begin{bmatrix} y|s|^{-1/\rho} \{-k_1 |s|^y \text{sign}(s) + z\} \\ -k_2 |s|^{y-\frac{1}{\rho}} \text{sign}(s) \end{bmatrix} = |s|^{-\frac{1}{\rho}} \begin{bmatrix} y\{-k_1 |s|^y \text{sign}(s) + z\} \\ -k_2 |s|^y \text{sign}(s) \end{bmatrix} \\ \dot{\zeta} &= |s|^{-\frac{1}{\rho}} \begin{bmatrix} -yk_1 & y \\ -k_2 & 0 \end{bmatrix} \begin{bmatrix} |s|^y \text{sign}(s) \\ z \end{bmatrix} = |s|^{-\frac{1}{\rho}} A \zeta \end{aligned} \tag{14}$$

where $A = \begin{bmatrix} -yk_1 & y \\ -k_2 & 0 \end{bmatrix}$ i.e. $\dot{\zeta} = |s|^{-\frac{1}{\rho}} A \zeta$.

The eigenvalues of A are the roots of Hurwitz polynomial:

$$|\lambda I - A| = \begin{vmatrix} \lambda + yk_1 & -y \\ k_2 & \lambda \end{vmatrix} = \lambda^2 + \lambda(yk_1) + (yk_2) = 0 \tag{15}$$

therefore $A = \begin{bmatrix} -yk_1 & y \\ -k_2 & 0 \end{bmatrix}$ is asymptotically stable.

Theorem 3.1. Consider a Lyapunov function $V = \zeta^T P \zeta$, where $P \in \mathbb{R}^{2 \times 2}$ is the positive definite and symmetric matrix satisfying the Lyapunov equation: $A^T P + P A = -Q$, where $Q \in \mathbb{R}^{2 \times 2}$ is the positive definite and symmetric matrix. Then $\dot{V} \leq -|s|^{-\frac{1}{\rho}} \zeta^T Q \zeta \leq 0$. Therefore, the system is stable. By using LaSalle’s invariance principle it can be shown that the system (13) is asymptotically stable.

Proof.

$$\begin{aligned}
 V &= \zeta^T P \zeta \\
 \dot{V} &= \zeta^T P \dot{\zeta} + \zeta^T P \dot{\zeta} \\
 \dot{V} &= |s|^{-\frac{1}{\rho}} [\zeta^T A^T P \zeta + \zeta^T P A \zeta] \\
 \dot{V} &= |s|^{-\frac{1}{\rho}} \zeta^T [A^T P + P A] \zeta \\
 \dot{V} &= -|s|^{-\frac{1}{\rho}} \zeta^T Q \zeta \leq 0.
 \end{aligned}$$

□

Step 3:

Apply the control inputs:

$$v_1 = 1 \tag{16}$$

$$v = v_{eq} + v_s \tag{17}$$

where

$$v_{eq} = -x_{n-1} - \sum_{i=1}^{n-3} c_i x_{n-1-i} \tag{18}$$

$$v_s = -k_1 |s|^{\frac{\rho-1}{\rho}} \text{sign}(s) + z \tag{19}$$

$$\dot{z} = -k_2 |s|^{\frac{\rho-2}{\rho}} \text{sign}(s) \tag{20}$$

where $k_1, k_2 > 0$, $\rho \geq 2$, until the system (3) reaches on a surface:

$$S = \{x \in \mathfrak{R}^n : x_n = \dots = x_3 = x_2 = 0, x_1 \neq 0\}. \tag{21}$$

Step 4:

Apply the control inputs $v_1 = -\text{sign}(x_1)$ and $v = 0$ until the system (3) reaches origin:

$$O = \{x \in \mathfrak{R}^n : x_n = \dots = x_3 = x_2 = x_1 = 0\}. \tag{22}$$

4. APPLICATION EXAMPLES

4.1. The two wheel car model

The two wheel car or unicycle model shown in Figure 1 represents a three-dimensional nonholonomic system with control deficiency order one and its controllability algebra contains Lie bracket of depth one. The kinematic model of a two wheel car is given as [9]:

$$\begin{bmatrix} \dot{\theta} \\ \dot{x} \\ \dot{y} \end{bmatrix} = \begin{bmatrix} 1 \\ 0 \\ 0 \end{bmatrix} u_1 + \begin{bmatrix} 0 \\ \cos \theta \\ \sin \theta \end{bmatrix} u_2. \tag{23}$$

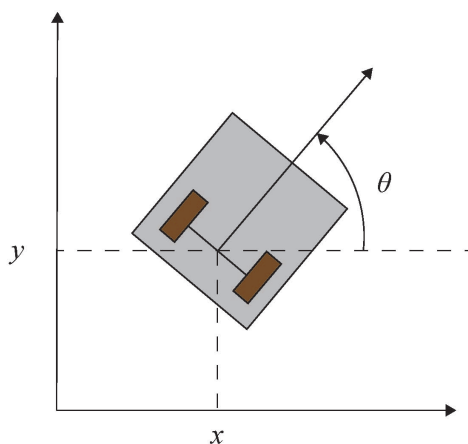

Fig. 1. A two wheel car model.

Introducing a new set of state variables $z = [z_1, z_2, z_3]^T = [\theta, x, y]^T$ the kinematics model (23) can be written as:

$$\begin{bmatrix} \dot{z}_1 \\ \dot{z}_2 \\ \dot{z}_3 \end{bmatrix} = \begin{bmatrix} 1 \\ 0 \\ 0 \end{bmatrix} u_1 + \begin{bmatrix} 0 \\ \cos z_1 \\ \sin z_1 \end{bmatrix} u_2. \tag{24}$$

or

$$\dot{z} = Z_1(z)u_1 + Z_2(z)u_2, z \in \mathfrak{R}^3$$

where

$$Z_1(z) = \begin{bmatrix} 1 \\ 0 \\ 0 \end{bmatrix} \quad \& \quad Z_2(z) = \begin{bmatrix} 0 \\ \cos z_1 \\ \sin z_1 \end{bmatrix}.$$

The kinematics model (24) satisfies Assumptions presented in Section 2. To verify properties (P1) and (P2), it is sufficient to calculate the following Lie bracket:

$$Z_3(z) = [Z_1, Z_2](z) = \begin{bmatrix} 0 \\ -\sin z_1 \\ \cos z_1 \end{bmatrix}.$$

4.1.1. Conversion into chained form

Consider the following transformation:

$$\begin{aligned} x_1 &= z_1 \\ x_2 &= z_2 \cos z_1 + z_3 \sin z_1 \\ x_3 &= z_2 \sin z_1 - z_3 \cos z_1 \\ v_1 &= u_1 \\ v_2 &= u_2 - x_3 u_1. \end{aligned} \tag{25}$$

This transforms the nonholonomic system (25) into the following chained form system:

$$\begin{aligned} \dot{x}_1 &= v_1 \\ \dot{x}_2 &= v_2 \\ \dot{x}_3 &= x_2 v_1. \end{aligned} \tag{26}$$

Then, the proposed algorithm can be used with the following sliding surface:

$$s = x_3 + x_2. \tag{27}$$

Figure 2 (a)–(c) shows response of the proposed controller and with the controller reported in [2]. The initial conditions are chosen the same as $[x_1(0), x_2(0), x_3(0)] = [2, -4, 3]$. The controller reported in [2] is based on robust adaptive technique. Since nonholonomic systems can only be stabilized either using discontinuous control, such as sliding mode, or some kind of time varying control, the control in [2] uses sliding

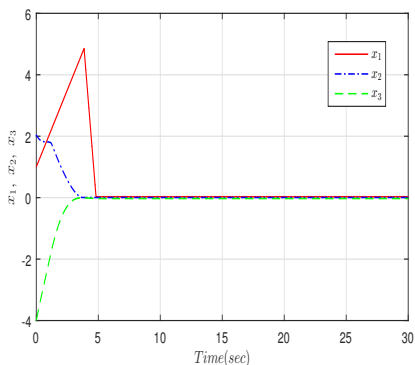

(a) System states: $(x_1, x_2, x_3) = (1, 2 - 4)$.

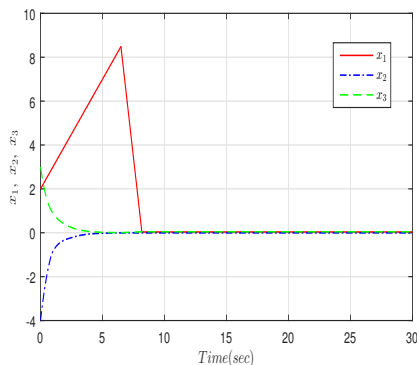

(b) System states: $(x_1, x_2, x_3) = (2, -4, 3)$.

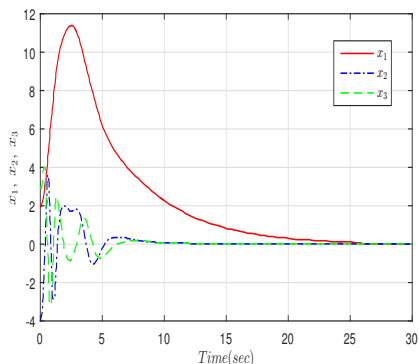

(c) System states in [2]: $(x_1, x_2, x_3) = (2, -4, 3)$.

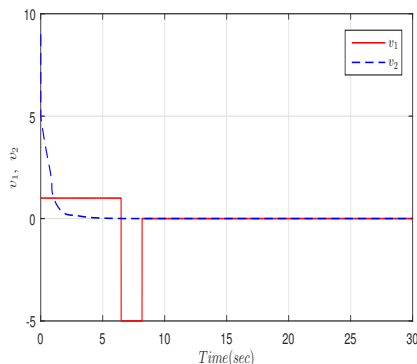

(d) Control effort v_1, v_2 .

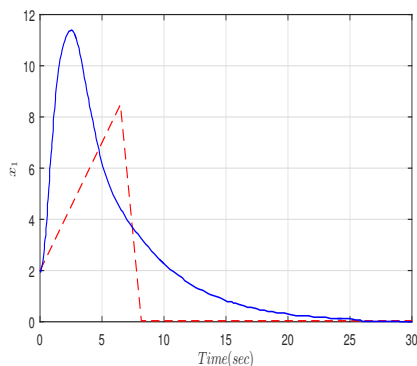

(e) System state x_1 : Doted line proposed and solid line as reported in [2].

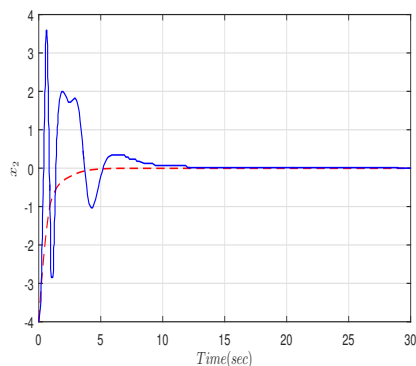

(f) System state x_2 : Doted line proposed and solid line as reported in [2].

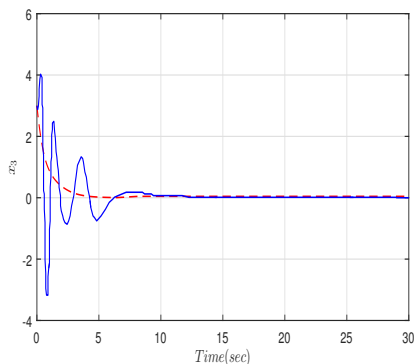

(g) System state x_3 : Doted line proposed and solid line as reported in [2].

Fig. 2. A two wheel car model: Comparison of the proposed controller and the controller reported in [2] for same initial conditions:

$$[x_1(0), x_2(0), x_3(0),] = [2, -4, 3].$$

mode control. Figure 2(d) shows the control inputs v_1, v_2 with gains $k_1 = 1, k_2 = 5$. Figure 2 (e)–(g) show system states x_1, x_2, x_3 represented by doted lines, converge to zero in 11, 5, and 6 seconds with proposed controller. The response of the controller reported in [2] is represented by solid lines which show the states converge to zero in 27, 13, and 14 seconds respectively. The proposed controller has an advantage in term of settling time. From the above discussion the controller response in [2] is slow as well as extremely oscillatory due to use of dynamic robust controller.

4.2. The front wheel car model

4.2.1. The kinematics model

The front wheel car model as shown in Figure 3 represents four- dimensional nonholonomic control system with control deficiency order two. Its controllability Lie algebra contains Lie brackets of depth one and two. The kinematics model of a front wheel car model is given as in [17]:

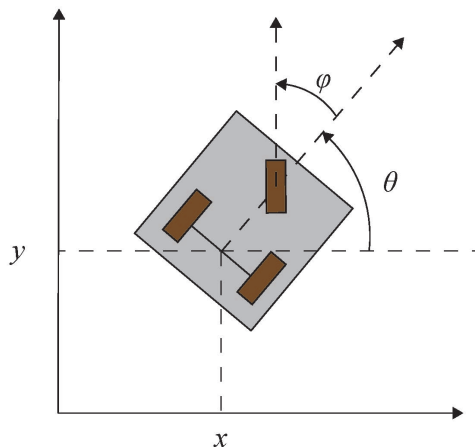

Fig. 3. A front wheel car model.

$$\begin{bmatrix} \dot{\varphi} \\ \dot{x} \\ \dot{\theta} \\ \dot{y} \end{bmatrix} = \begin{bmatrix} 1 \\ 0 \\ 0 \\ 0 \end{bmatrix} u_1 + \begin{bmatrix} 0 \\ \cos \theta \\ \frac{1}{l} \tan \varphi \\ \sin \theta \end{bmatrix} u_2. \tag{28}$$

Where, (x, y) : the center coordinate of the rear axle of the car,
 φ : the steering angle of the front wheel of the car,
 θ : the orientation of the car body with respect to x-axis,
 l : the distance between the front and rear axles of the car.

Assuming that $l = 1$ and introducing a new set of state variables $z \stackrel{\text{def}}{=} (z_1, z_2, z_3, z_4) = (\varphi, x, y, \theta)$ the kinematics model (28) can be written as:

$$\begin{bmatrix} \dot{z}_1 \\ \dot{z}_2 \\ \dot{z}_3 \\ \dot{z}_4 \end{bmatrix} = \begin{bmatrix} 1 \\ 0 \\ 0 \\ 0 \end{bmatrix} u_1 + \begin{bmatrix} 0 \\ \cos z_4 \\ \sin z_4 \\ \tan z_1 \end{bmatrix} u_2 \tag{29}$$

or

$$\dot{z} = Z_1(z)u_1 + Z_2(z)u_2, z \in \mathbb{R}^4$$

where

$$Z_1(z) = \begin{bmatrix} 1 \\ 0 \\ 0 \\ 0 \end{bmatrix} \quad \& \quad Z_2(z) = \begin{bmatrix} 0 \\ \cos z_4 \\ \sin z_4 \\ \tan z_1 \end{bmatrix}.$$

The kinematics model (29) satisfies Assumptions presented in Section 2. To verify properties (P1) and (P2), it is sufficient to calculate the following Lie brackets of $Z_1(z)$ & $Z_2(z)$:

$$Z_3(z) = [Z_1, Z_2](z) = \begin{bmatrix} 0 \\ 0 \\ 0 \\ \sec^2 z_1 \end{bmatrix} \quad \& \quad Z_4(z) = [Z_2, Z_3](z) = \begin{bmatrix} 0 \\ -\sin z_4 \sec^2 z_1 \\ \cos z_4 \sec^2 z_1 \\ 0 \end{bmatrix}$$

which satisfy the LARC condition:

$$span\{Z_1, Z_2, Z_3, Z_4\}(z) = \mathbb{R}^4 \quad \forall z \in \mathbb{R}^4.$$

4.2.2. Conversion into chained form

Consider the following transformation:

$$\begin{aligned} x_1 &= x = z_2 \\ x_2 &= \frac{\tan \varphi}{l \cos^3 \theta} = \frac{\tan z_1}{l \cos^3 z_4} \\ x_3 &= \tan \theta = \tan z_4 \\ x_4 &= y = z_3 \\ v_1 &= \cos \theta u_1 = \cos z_4 u_1 \\ v_2 &= \frac{1 + \tan^2 \varphi}{l \cos^3 \theta} u_1 + \frac{3 \tan \theta \tan^2 \varphi}{l^2 \cos^3 \theta} u_2 \\ &= \frac{1 + \tan^2 z_1}{l \cos^3 z_4} u_1 + \frac{3 \tan z_4 \tan^2 z_1}{l^2 \cos^3 z_4} u_2. \end{aligned} \tag{30}$$

Transforms the nonholonomic system (30) into the following chained form system:

$$\begin{aligned} \dot{x}_1 &= v_1 \\ \dot{x}_2 &= v_2 \\ \dot{x}_3 &= x_2 v_1 \\ \dot{x}_4 &= x_3 v_1. \end{aligned} \tag{31}$$

The proposed algorithm was applied to sliding surface:

$$s = x_4 + 2x_3 + x_2. \tag{32}$$

Figure 4 (a) – (c) shows response of the proposed controller and with the controller reported in [17]. The initial conditions are chosen the same as $[x_1(0), x_2(0), x_3(0), x_4(0)] = [0.3, 0.4, 0.2, 0.5]$. The controller reported in [17] is based on model decomposition technique. Since nonholonomic systems can only be stabilized either using discontinuous control, such as sliding mode, or some kind of time-varying control, the control in [17]

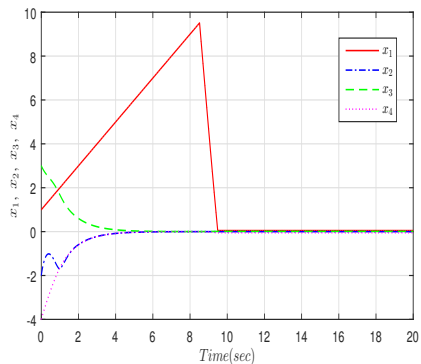

(a) System states: $(x_1, x_2, x_3, x_4) = (1, -2, 3, -4)$.

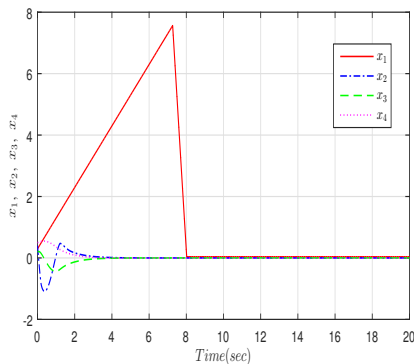

(b) System states: $(x_1, x_2, x_3, x_4) = (0.3, 0.4, 0.2, 0.5)$.

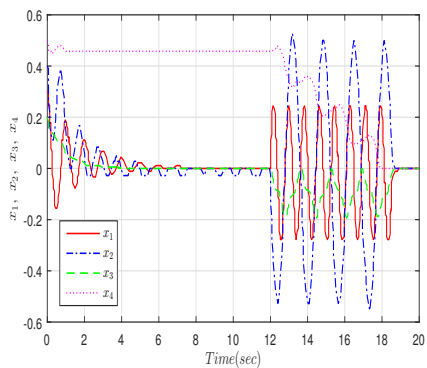

(c) System states as presented in [17].

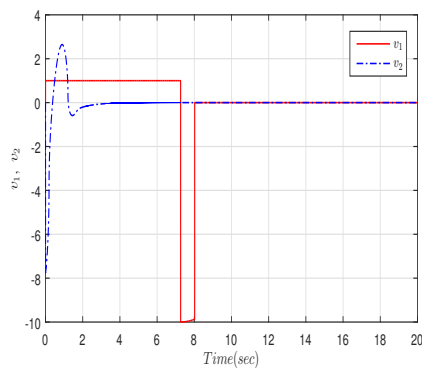

(d) Control input: v_1, v_2 .

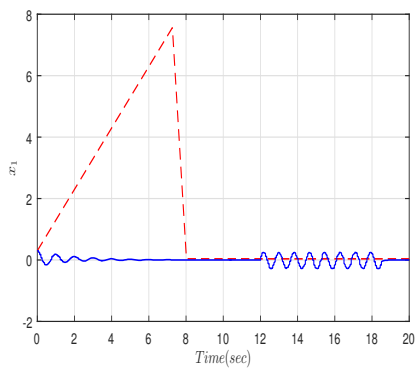

(e) System state x_1 : Dotted line proposed and solid line as reported in [17].

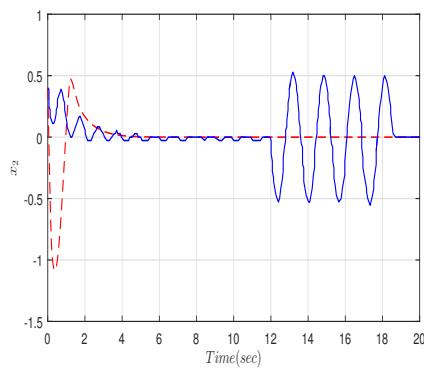

(f) System state x_2 : Dotted line proposed and solid line as reported in [17].

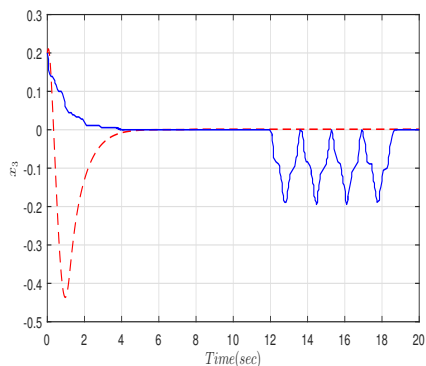

(g) System state x_3 : Doted line proposed and solid line as reported in [17]

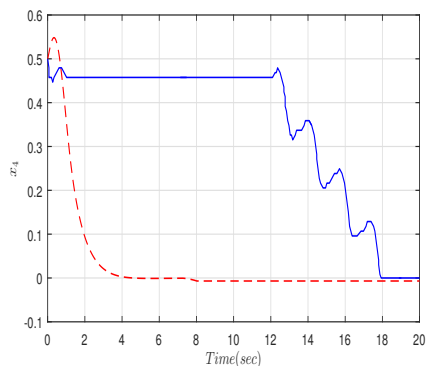

(h) System state x_4 : Doted line proposed and solid line as reported in [17]

Fig. 4. A front wheel car model: Comparison of the proposed controller and the controller reported in [17] for same initial conditions: $[x_1(0), x_2(0), x_3(0), x_4(0)] = [0.3, 0.4, 0.2, 0.5]$.

uses time-varying sinusoidal functions. Figure 4(d) shows the control inputs v_1, v_2 with gains $k_1 = 4, k_2 = 10$. Figure 4: (e)–(h) show system states x_1, x_2, x_3, x_4 represented by dotted lines, converge to zero in 12,6,5 and 4 seconds with proposed controller. The response of the controller reported in [17] is represented by solid lines which show the states converge to zero in 18 seconds respectively. The proposed controller has an advantage in term of settling time. From the above discussion the controller response in [17] is slow as well as extremely oscillatory due to use of time-varying sinusoidal functions.

4.3. The fire truck model

4.3.1. The kinematics model of a fire truck

The fire truck as shown in Figure 5 is an example of a nonholonomic system with three inputs and six configuration variables, for which the controllability Lie algebra contains two Lie brackets of depth one and one Lie bracket of depth two.

By defining the states variables as $z = (z_1, z_2, z_3, z_4, z_5, z_6)^T = (x, y, \varphi_0, \theta_0, \varphi_1, \theta_1)^T$ and assuming $l_0 = l_1 = 1$ in the kinematics model of fire truck as given in [17] we have the following:

$$\dot{z} = Z_0(z)u_1 + Z_2(z)u_2 + Z_3(z)u_3 \tag{33}$$

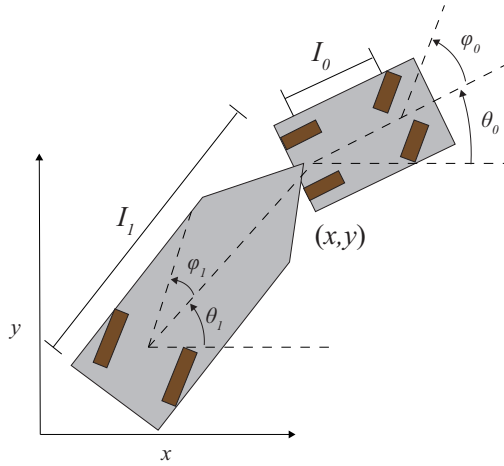

Fig. 5. A firetruck model.

where,

$$Z_0(z) = \begin{bmatrix} \cos z_4 \\ \sin z_4 \\ 0 \\ \tan z_3 \\ 0 \\ -\sin(z_6 - z_4 + z_5) \sec z_5 \end{bmatrix}, \quad Z_2(z) = \begin{bmatrix} 0 \\ 0 \\ 1 \\ 0 \\ 0 \\ 0 \end{bmatrix}, \quad Z_3(z) = \begin{bmatrix} 0 \\ 0 \\ 0 \\ 0 \\ 1 \\ 0 \end{bmatrix}.$$

Where (x, y) : the center coordinate of the rear axle of the cab

φ_0 : the steering angle of the front wheel of the cab

θ_0 : the orientation of the cab body with respect to x-axis

φ_1 : the steering angle of the rear wheel of the trailer

θ_1 : the orientation of the trailer with respect to x-axis

l_0 : the distance between the front and rear axles of the cab

l_1 : the distance between the centers of the rear axles of the cab and trailer.

The system (33) can be rewritten as:

$$\dot{z} = Z_1(z)\bar{u}_1 + Z_2(z)u_2 + Z_3(z)u_3 \tag{34}$$

where,

$$Z_1(z) = \frac{Z_0(z)}{\cos z_4} = \begin{bmatrix} 1 \\ \tan z_4 \\ 0 \\ \tan z_3 \sec z_4 \\ 0 \\ -\sin(z_6 - z_4 + z_5) \sec z_5 \sec z_4 \end{bmatrix}, \quad Z_2(z) = \begin{bmatrix} 0 \\ 0 \\ 1 \\ 0 \\ 0 \\ 0 \end{bmatrix},$$

$$Z_3(z) = \begin{bmatrix} 0 \\ 0 \\ 0 \\ 0 \\ 1 \\ 0 \end{bmatrix}, \bar{u}_1 = \cos z_4 u_1.$$

It can be verified that the system (34) satisfies the following assumptions presented in section 2. To verify properties (P1) and (P2), calculate the Lie brackets, which are linearly independent at the origin:

$$Z_4(z) = [Z_1, Z_2](z) = \begin{bmatrix} 0 \\ 0 \\ 0 \\ -\sec^2 z_3 \sec z_4 \\ 0 \\ 0 \end{bmatrix}$$

$$Z_5(z) = [Z_1, Z_3](z) = \begin{bmatrix} 0 \\ 0 \\ 0 \\ 0 \\ 0 \\ \sec^2 z_5 \sec z_4 \cos(z_6 - z_4) \end{bmatrix}$$

$$Z_6(z) = [Z_1, [Z_1, Z_2]](z) = \begin{bmatrix} 0 \\ \sec^2 z_3 \sec^3 z_4 \\ 0 \\ 0 \\ 0 \\ \sec^2 z_3 \sec^3 z_4 \sec z_5 \cos(z_6 + z_5) \end{bmatrix}.$$

It is clear that, if the motion of the system is restricted to the manifold:

$$M \stackrel{\text{def}}{=} \{z \in \mathfrak{R}^6 : |z_i| < \frac{\pi}{2}, i = 3, 4, 5\}. \quad (35)$$

Then the LARC condition namely: $\text{span}\{Z_1(z), Z_2(z), \dots, Z_6(z)\} = \mathfrak{R}^6 \quad \forall z \in M$ is satisfied.

4.3.2. Conversion into chained form

Consider the following transformation:

$$\begin{aligned}
 x_1 &= z_1 \\
 x_2 &= \sec^3 z_4 \tan z_3 \\
 x_3 &= \tan z_4 \\
 x_4 &= z_2 \\
 x_5 &= -\sin(z_5 - z_4 + z_6) \sec z_5 \sec z_4 \\
 x_6 &= z_6
 \end{aligned} \tag{36}$$

$$\begin{aligned}
 v_1 &= \bar{u}_1 = \cos z_4 u_1 \\
 v_2 &= a_1 \bar{u}_1 + a_2 u_2 \\
 v_3 &= a_3 \bar{u}_1 + a_4 u_3.
 \end{aligned}$$

Where

$$\begin{aligned}
 a_1 &= 3 \tan^2 z_3 \tan z_4 \sec^4 z_4 \\
 a_2 &= \sec^2 z_3 \sec^3 z_4 \\
 a_3 &= \cos(z_5 - z_4 + z_6) \tan z_3 \sec z_5 \sec^2 z_4 + \cos(z_5 - z_4 + z_6) \sin(z_5 - z_4 + z_6) \sec^2 z_5 \sec^2 z_4 \\
 &\quad - \sin(z_5 - z_4 + z_6) \sec z_5 \sec^2 z_4 \tan z_3 \tan z_4 \\
 a_4 &= -\cos(z_5 - z_4 + z_6) \sec z_4 \sec z_5 - \sin(z_5 - z_4 + z_6) \sec z_5 \sec z_4 \tan z_5.
 \end{aligned}$$

Transform the nonholonomic system (36) into the following chained form system:

$$\begin{aligned}
 \dot{x}_1 &= v_1 \\
 \dot{x}_2 &= v_2 \\
 \dot{x}_3 &= x_2 v_1 \\
 \dot{x}_4 &= x_3 v_1 \\
 \dot{x}_5 &= v_3 \\
 \dot{x}_6 &= x_5 v_1.
 \end{aligned} \tag{37}$$

The proposed algorithm was applied with the sliding surface for subsystem S_2 as:

$$s = x_6 + 4x_5 + 6x_4 + 4x_3 + x_2. \tag{38}$$

Figure 6 (a)–(c) shows response of the proposed controller and with the controller reported in [17]. The initial conditions are chosen the same as $[x_1(0), x_2(0), x_3(0), x_4(0), x_5(0), x_6(0)] = [0.8, 0.5, 0.7, 0.3, 0.6, 0.4]$. The controller reported in [17] is based on model decomposition technique. Since nonholonomic systems can only be stabilized either using discontinuous control, such as sliding mode, or some kind of time-varying control, the control in [17] uses time varying sinusoidal functions. Figure 6(d) shows the control inputs v_1, v_2 with gains $k_1 = 10, k_2 = 20$. Figure 6 (e)–(j) show system states $x_1, x_2, x_3, x_4, x_5, x_6$ represented by dotted lines, converge to zero in 35, 8, 8, 11, 11 and 11 seconds with proposed controller. The response of the controller reported in [17] is represented by solid lines which show the states converge to zero in 25, 19, 32, 19, 22 and 19 seconds respectively. The proposed controller has an advantage in term of settling time. From the above discussion the controller response in [17] is slow as well as extremely oscillatory due to use of time varying sinusoidal functions.

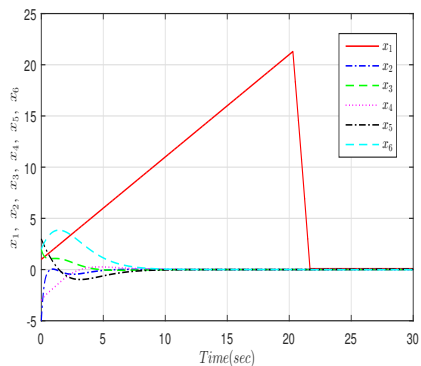

(a) System states: $(x_1, x_2, x_3, x_4, x_5, x_6) = (1, -5, 2, -3, 3, 2)$.

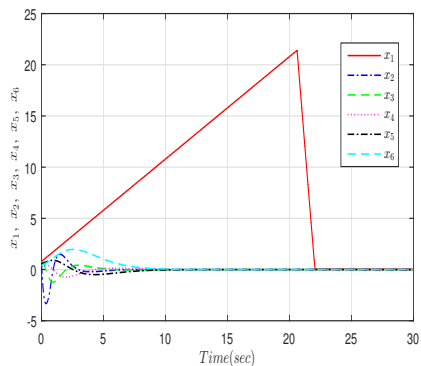

(b) System states: $(x_1, x_2, x_3, x_4, x_5, x_6) = (0.8, 0.5, 0.7, 0.3, 0.6, 0.4)$.

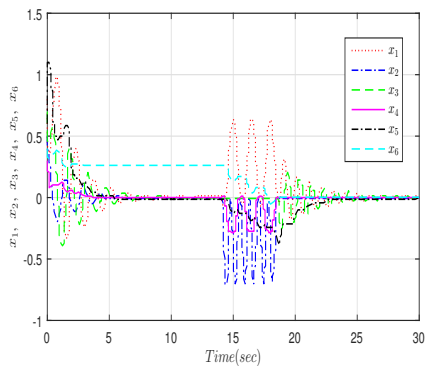

(c) System states as presented in [17]: $(x_1, x_2, x_3, x_4, x_5, x_6) = (0.8, 0.5, 0.7, 0.3, 0.6, 0.4)$.

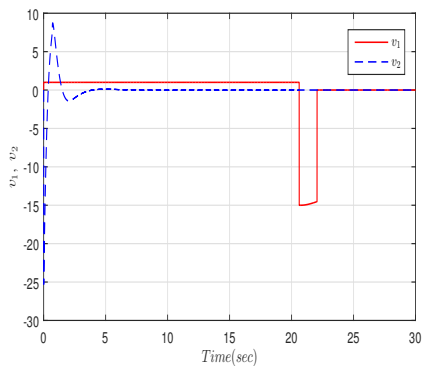

(d) Control input: v_1, v_2 .

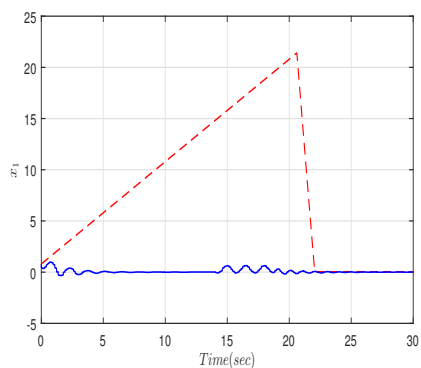

(e) System state x_1 : Dotted line proposed and solid line as reported in [17].

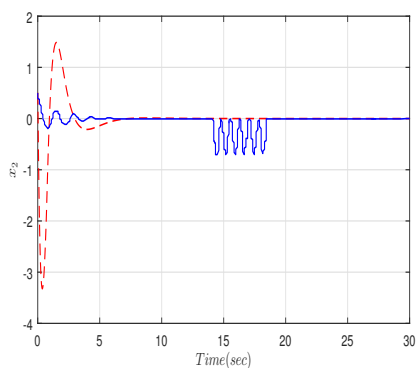

(f) System state x_2 : Dotted line proposed and solid line as reported in [17].

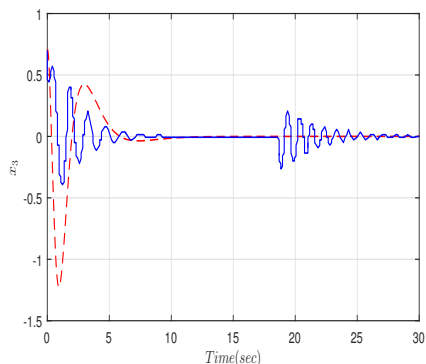

(g) System state x_3 : Doted line proposed and solid line as reported in [17].

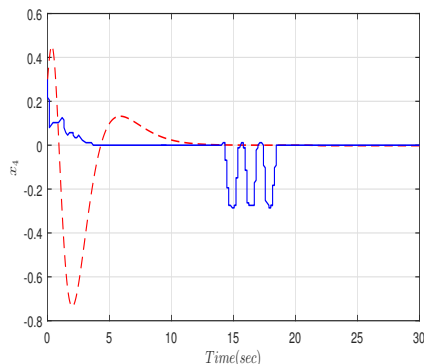

(h) System state x_4 : Doted line proposed and solid line as reported in [17].

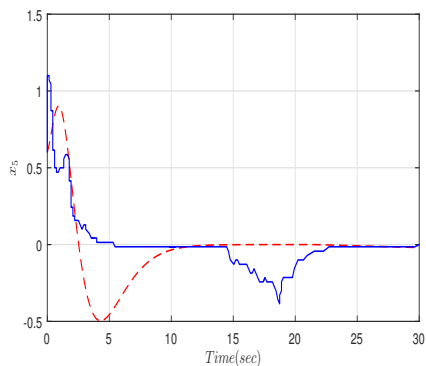

(i) System state x_5 : Doted line proposed and solid line as reported in [17].

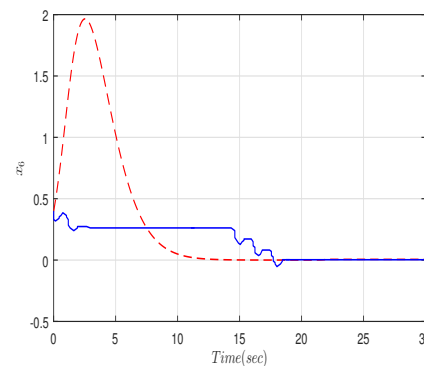

(j) System state x_6 : Doted line proposed and solid line as reported in [17].

Fig. 6. A firetruck model: Comparison of the proposed controller and the controller reported in [17] for same initial conditions: $[x_1(0), x_2(0), x_3(0), x_4(0), x_5(0), x_6] = [0.8, 0.5, 0.7, 0.3, 0.6, 0.4]$.

5. CONCLUSION

A smooth super twisting sliding mode based steering control for nonholonomic systems which are transformable into chained form is presented. The proposed method is tested on three nonholonomic systems which are transformable into chained form; a two-wheel car model, a model of front-wheel car and a firetruck model. The aim was to steer the systems from any initial condition to a desired value which was assumed to be zero. The simulation results show the correctness and the effectiveness of the proposed controller for the chained form nonholonomic systems, when compared to already existing methods.

It is evident from the simulation results that the objective has been achieved.

(Received June 21, 2017)

REFERENCES

- [1] W. Abbasi and F. Rehman: Adaptive integral sliding mode stabilization of nonholonomic drift-free systems. *Math. Problems Engrg.* *2016* (2016), 1–11. DOI:10.1155/2016/9617283
- [2] S. sam Ge, J. Wang, T. heng Lee, and GY. Zhou: Adaptive robust stabilization of dynamic nonholonomic chained systems. *J. Field Robotics* *18* (2001), 3, 119–133. DOI:10.1002/rob.1010.abs
- [3] I. Kolmanovsky and N.H. McClamroch: Developments in nonholonomic control problems. *IEEE Control Systems* *15* (1995), 6, 20–36. DOI:10.1109/37.476384
- [4] A. Levant: Higher-order sliding modes, differentiation and output-feedback control. *Int. J. Control* *76* (2003), 9–10, 924–941. DOI:10.1080/0020717031000099029
- [5] L. Zhen-Ying and C-Li. Wang: Robust stabilization of nonholonomic chained form systems with uncertainties. *Acta Automat. Sinica* *37* (2011), 2, 129–142. DOI:10.3724/sp.j.1004.2011.00129
- [6] P. Li and Z. Zheng: Global finite-time stabilization of planar nonlinear systems with disturbance. *Asian J. Control* *14* (2012), 3, 851–858. DOI:10.1002/asjc.377
- [7] Z. Li, H. Xiao, C. Yang, and Y. Zhao: Model predictive control of nonholonomic chained systems using general projection neural networks optimization. *IEEE Trans. Systems Man Cybernetics: Systems* *45* (2015), 10, 1313–1321. DOI:10.1109/tsmc.2015.2398833
- [8] L. Luque-Vega, B. Castillo-Toledo, and A.G. Loukianov: Robust block second order sliding mode control for a quadrotor. *J. Franklin Inst.* *349* (2012), 2, 719–739. DOI:10.1016/j.jfranklin.2011.10.017
- [9] S. Mobayen: Fast terminal sliding mode tracking of non-holonomic systems with exponential decay rate. *IET Control Theory Appl.* *9* (2015), 8, 1294–1301. DOI:10.1049/iet-cta.2014.1118
- [10] S. Mobayen: Finite-time tracking control of chained-form nonholonomic systems with external disturbances based on recursive terminal sliding mode method. *Nonlinear Dynamics* *80* (2015), 1–2, 669–683. DOI:10.1007/s11071-015-1897-4
- [11] S. Mobayen and D. Baleanu: Linear matrix inequalities design approach for robust stabilization of uncertain nonlinear systems with perturbation based on optimally-tuned global sliding mode control. *J. Vibration Control* *23*, (2017), 8, 1285–1295. DOI:10.1177/1077546315592516
- [12] J. A. Moreno and M. Osorio: A Lyapunov approach to second-order sliding mode controllers and observers. In: *Proc. 47th IEEE Conference on Decision and Control 2008*, pp. 2856–2861. DOI:10.1109/cdc.2008.4739356
- [13] J. A. Moreno and M. Osorio: Strict Lyapunov functions for the super-twisting algorithm. *IEEE Trans. Automat. Control* *57* (2012), 4, 1035–1040. DOI:10.1109/tac.2012.2186179
- [14] R.M. Murray and S.S. Sastry: Steering nonholonomic systems in chained form. In: *Proc. 30th IEEE Conference on Decision and Control* *2* (1991), pp.1121–1126. DOI:10.1109/cdc.1991.261508

- [15] I. Nagesh and C. Edwards: A multivariable super-twisting sliding mode approach: A field-oriented control approach. *Automatica* 50 (2014), 3, 984–988. DOI:10.1016/j.automatica.2013.12.032
- [16] J. Picó, E. Picó-Marco, A. Vignoni, and H. De Battista: Stability preserving maps for finite-time convergence: super-twisting sliding-mode algorithm. *Automatica* 49 (2013), 2, 534–539. DOI:10.1016/j.automatica.2012.11.022
- [17] F. Rehman: Feedback stabilization of nonholonomic control systems using model decomposition. *Asian J. Control* 7, (2005), 3, 256–265. DOI:10.1111/j.1934-6093.2005.tb00235.x
- [18] Y.B. Shtessel, I.A. Shkolnikov, and A. Levant: Smooth second-order sliding modes: Missile guidance application. *Automatica* 43 (2007), 8, 1470–1476. DOI:10.1016/j.automatica.2007.01.008
- [19] O. J. Sordalen and O. Egeland: Exponential stabilization of nonholonomic chained systems. *IEEE Trans. Automat. Control* 40 (1995), 1, 35–49. DOI:10.1109/9.362901
- [20] Y. Wang, Z. Miao, H. Zhong, and Qi. Pan: Simultaneous stabilization and tracking of nonholonomic mobile robots: A Lyapunov-based approach. *IEEE Trans. Control Systems Technol.* 23 (2015), 4, 1440–1450. DOI:10.1109/tcst.2014.2375812
- [21] V. Utkin, J. Guldner, J. Shi, S. Ge, and F. Lewis: Sliding Mode Control in Electro-mechanical Systems. Second Edition. Boca Raton: CRC Press, 2009. DOI:10.1201/9781420065619

*Waseem Abbasi, Capital University of Science and Technology, Islamabad. Pakistan.
e-mail: waseemabbasi97@gmail.com*

*Fazal ur Rehman, Capital University of Science and Technology, Islamabad. Pakistan.
e-mail: drfrehman@gmail.com*

*Ibrahim Shah, Capital University of Science and Technology, Islamabad. Pakistan.
e-mail: ebraheemshah@yahoo.com*